

# Missing Measurements I

Please add the missing measurements to the boxes.

Name: \_\_\_\_\_

Score: \_\_\_\_\_

/10

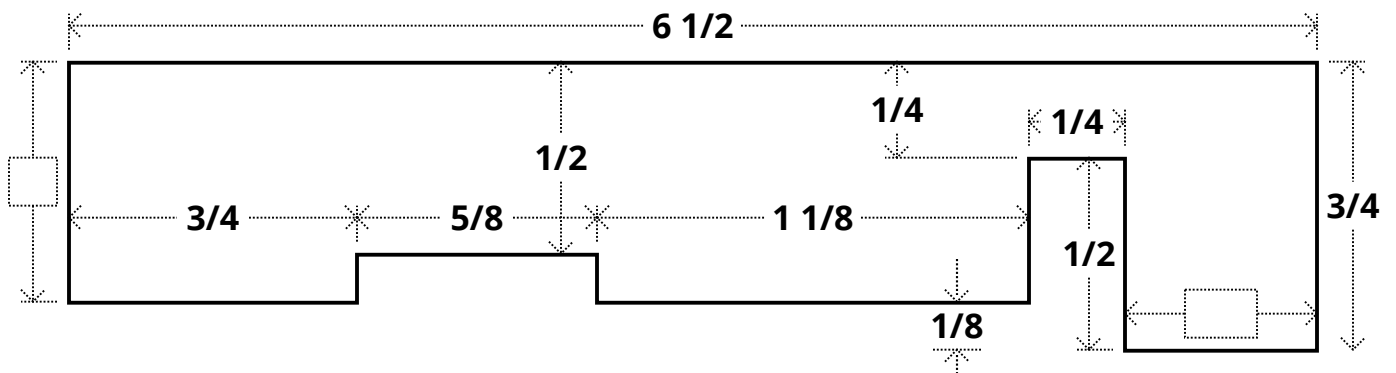
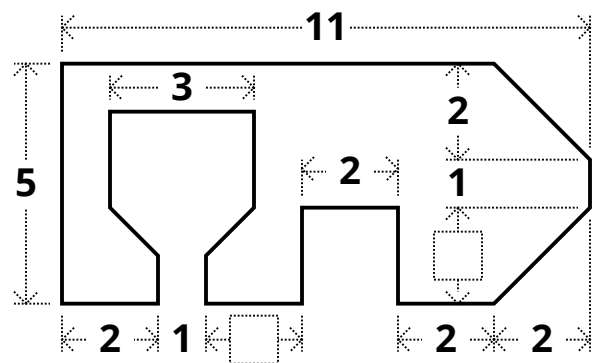
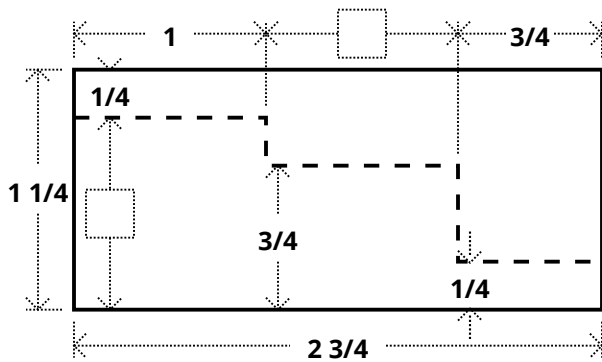
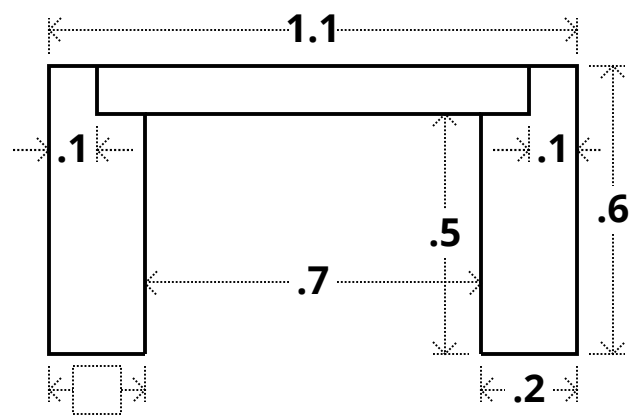
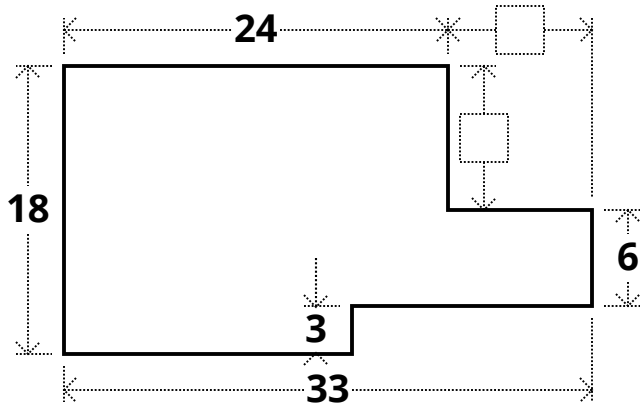
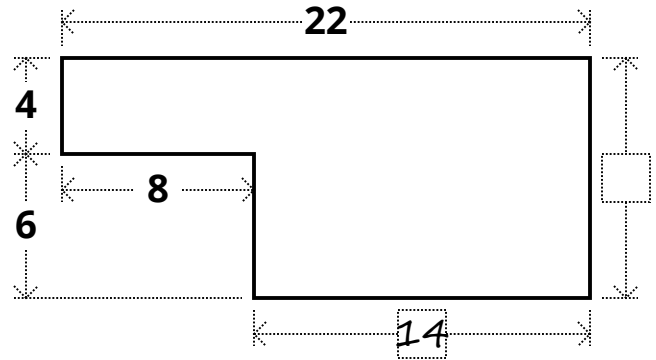
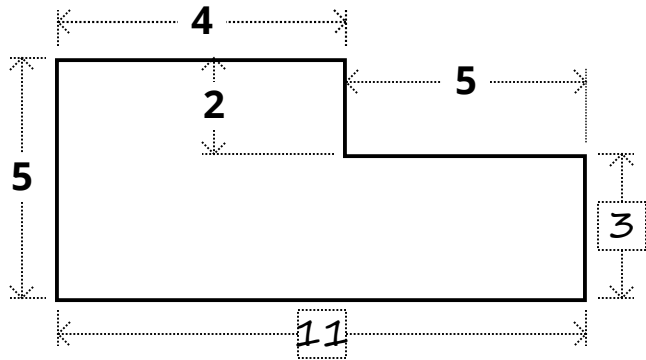

# Missing Measurements II

Please add the missing measurements to the boxes.

Name: \_\_\_\_\_

Score: \_\_\_\_\_

/10

